



EOTECH®

2020
CATALOG





A LEADER IN IMAGING SYSTEMS

**EOTECH® THE FUTURE OF
OPTICS, THERMAL AND
NIGHT VISION TECHNOLOGY**

EOTECH is a leader in imaging innovation. With a full portfolio of products, including holographic weapon sights, precision rifle scopes, thermal and night vision systems, and laser aiming solutions, EOTECH is a complete system supplier. EOTECH is dedicated to providing rugged, reliable and innovative products that offer a true advantage to all who use them.



CONTENTS

- 06 / **EOTECH® HOLOGRAPHIC WEAPON SIGHTS**
HWS® FEATURES
NIGHT VISION-COMPATIBLE EXPS3 / 552 / XPS3 / 558
NON-NIGHT VISION-COMPATIBLE XPS2 GREY / XPS2 GREEN /
XPS2 / 512 / EXPS2 / EXPS2GRN / 518 / 300BLK / XBOW
- 18 / **MAGNIFIERS**
MAGNIFIER FEATURES
MAGNIFIERS G45 / G43 / G33 / G30
HOLOGRAPHIC HYBRID SIGHTS HHS GREEN / HHS I /
HHS II / HHS III
- 26 / **HWS RETICLE ADVANTAGES**
- 28 / **HWS RETICLE PATTERNS**
- 30 / **VUDU® PRECISION OPTICS**
RIFLE SCOPE FEATURES
RIFLE SCOPES 1-8X24SFP / 1-6X24FFP / 2.5-10X44FFP /
3.5-18X50FFP / 5-25X50FFP / 3.5-18X50SFP / 8-32X50SFP /
CANTILEVER MOUNT
- 38 / **VUDU® RETICLE PATTERNS**
- 40 / **NOTES**



HWS[®]

HOLOGRAPHIC WEAPON SIGHTS

FEATURES

WHY A HOLOGRAPHIC SIGHT?

EOTECH® Holographic Weapon Sights (HWS®) are among the fastest target acquisition optics in the world. Situational awareness is provided through the heads-up display that supports engagement with two eyes open. The system optimizes the operator's peripheral vision capacity, and even with the sight window shattered or partially obstructed by mud, snow or rain, the sight will still function effectively.



BATTERY TYPE

Choose between units that are powered by two different battery types

The models that use two AA batteries increase battery life and are more readily available

The models that use the CR123 lithium battery are more compact, taking up less rail space



NIGHT VISION

Choose between units that are either night vision-compatible or non-night vision-compatible

Night vision models have 10 additional brightness settings



RAIL MOUNT

Choose between units that are cross bolt mounted (Hex or Thumb screw) or have a quick-detach lever

Either style mounts to a standard 1" Weaver or MIL-STD-1913 rail

Cross bolt models are absolute co-witness; throw level models are lower 1/3 co-witness



BUTTON LOCATION

Depending on the model, buttons may be on the side or on the rear of the unit

If using an EOTECH magnifier with your HWS, buttons on the side make it easier to adjust brightness levels



RETICLE STYLE

EOTECH offers a range of holographic reticle styles (the last digits within the HWS model number indicate the reticle style for that unit)



WATER-RESISTANCE

Depending on the unit, EOTECH sights are water-resistant up to either 33 ft. (10 m) or 10 ft. (3 m)

HWS® PERFORMANCE CHARACTERISTICS

APPLIES TO MOST MODELS

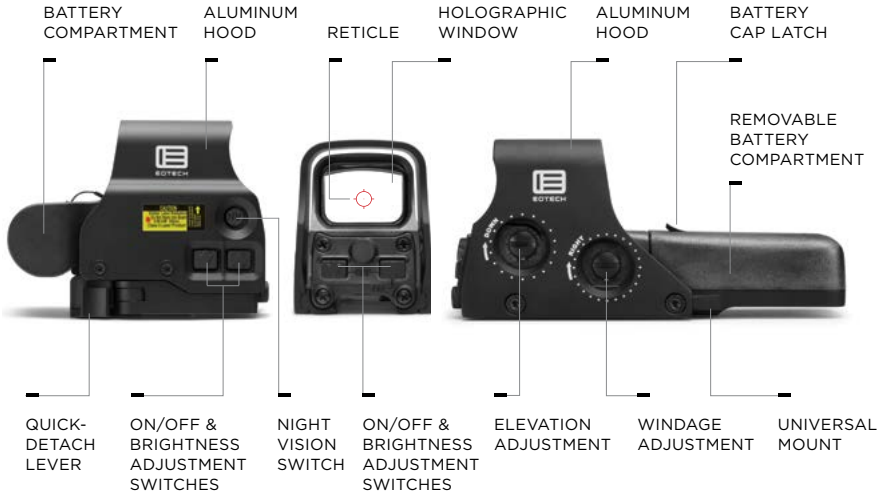

EO TECH / HWS

UNIT POWER

Multiple brightness settings (some models are compatible with night vision use)

Common batteries (AA or CR123)

Long battery life with auto battery check indicator

User-controlled auto shutdown (at 4 or 8 hours)

OPERATION

Holographic optics, internally sealed and fog-resistant for all-weather performance

Rugged — operates with shattered or partially obstructed sight window

Unlimited eye relief, adaptable to various weapon platforms

No reticle “washout” in bright sunlight or against white targets

HEADS-UP DISPLAY

Scratch-resistant, anti-reflective coating on external surfaces

Rectangular viewing window for wide Field-of-View (FOV)

Adjustment range at minimum +/- 40 MOA travel at ½ MOA per click



THE EOTECH® ADVANTAGE

RETICLE

FAST TARGET ACQUISITION

The “Speed Ring” reticle guides the eye to the center aiming dot for faster target acquisition.

FIELD-OF-VIEW

IMPROVED VIEW

Large rectangular window allows users to see more, aiding in improved situational awareness.

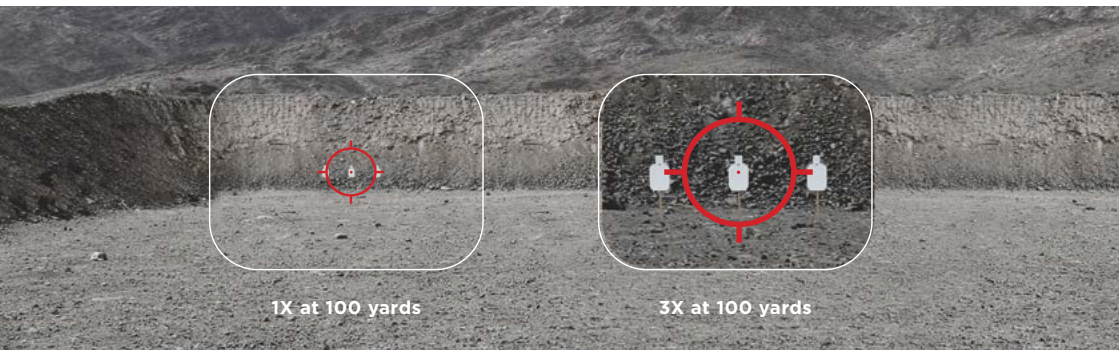

1X at 100 yards

3X at 100 yards

MAGNIFICATION

The aiming dot does not expand when viewed with typical magnification. In tandem with a 3X or 5X magnifier, the dot size does not increase noticeably, while the target is magnified, offering much greater precision.



EOTECH®

== AWARDED ==

USSOCOM

**CLOSE-QUARTERS
BATTLE SIGHT**

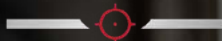

BATTLE-PROVEN

USSOCOM 2018 AWARD CLOSE-QUARTERS COMBAT SIGHT

U.S. Special Operations Command

L3 Technologies Awarded Special Operations Command Contract for EOTECH® Optics

Under this contract with U.S. Special Operations Command (USSOCOM), EOTECH will provide close-quarters, single sights and clip-on magnifiers from its EOTECH brand for the Miniature Aiming System-Day Optics suite. This marks the continuation of an 18-year relationship between USSOCOM and EOTECH.



MODEL **EXPS3™**

- EXPS3-0
- EXPS3-2
- EXPS3-4*
- EXPS3-0 TAN
- EXPS3-2 TAN

- BLACK
- TAN

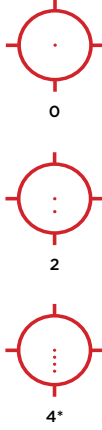

The EXPS3 is an excellent choice for professionals. The EXPS3 offers true two eyes open shooting for fast target acquisition, night vision-compatible settings, and a 7 mm raised base for lower iron sight access. It also has side buttons and an adjustable, locking, quick-detach lever for easy installation and removal.

*AIMING DOTS ON THE 4-DOT RETICLE MAY NOT BE DISTINGUISHABLE WITHOUT MAGNIFICATION.

MODEL
552™

552.A65
552.XR308

BLACK

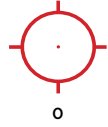

The Model 552 is the most popular night vision-compatible holographic weapon sight offered. The AA battery model has been used around the world and is compatible on both 1" Weaver and MIL-STD-1913 rails.



MODEL
XPS3™

XPS3-0
XPS3-2

BLACK

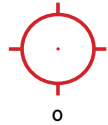

The shortest and lightest HWS night vision-compatible sight yet. With a single CR123 lithium battery configuration, the XPS provides additional rail space, leaving more room for rear iron sights, magnifiers or night vision mount.

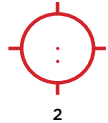

MODEL
558™

558.A65

BLACK

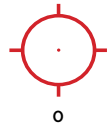

Perfect for anyone that doesn't like to sacrifice. The 558 is compatible with all Gen I-III night vision devices and features an adjustable, locking, quick-detach mount that offers instant removal.



MODEL **XPS2™**

XPS2-OGREY

GREY



The shortest and lightest HWS now offered in a limited edition grey. With a single CR123 lithium battery configuration, the XPS provides additional rail space, leaving more room for rear iron sights or magnifiers.



MODEL

XPS2™

GREEN RETICLE

XPS2-0GRN

BLACK



The most compact and lightweight HWS matched with an easy-to-see Green reticle. The Green reticle is approximately 6X easier to see than red in daytime, which can lead to faster target acquisition. With a single CR123 lithium battery configuration, the XPS provides additional rail space, leaving more room for rear iron sights or magnifiers. Also offering water-resistant capability up to 10 feet, the XPS2 is a great compact option for your platform.

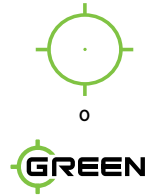

MODEL

XPS2™

XPS2-0 XPS2-SAGE
XPS2-1 XPS2-FN
XPS2-2

BLACK



The shortest and lightest HWS sight yet. With a single CR123 lithium battery configuration, the XPS2 provides additional rail space, leaving more room for rear iron sights or magnifiers. Also offering water-resistant capability up to 10 feet, the XPS2 is a great compact and lightweight option for your platform.

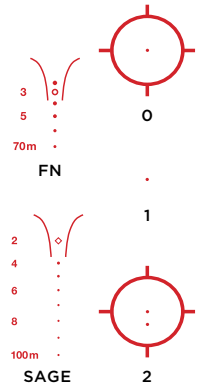

EOTECH / HWS NON-NIGHT VISION-COMPATIBLE

MODEL
512™

512.A65

██████████
BLACK

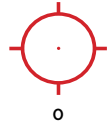

Perfect for anyone who wants fast target acquisition, reliability and durability without night vision capability, the Model 512 is the most popular HWS in the line.

MODEL
EXPS2™

EXPS2-0
EXPS2-2

██████████
BLACK

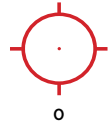

The Model EXPS2 maximizes rail space with its compact size and allows for co-witnessing of iron sights. It has convenient side buttons to add a magnifier and features an adjustable, locking, quick-detach lever for easy attachment and removal.

MODEL
EXPS2™
GREEN RETICLE

EXPS2-0GRN

██████████
BLACK



Achieve faster target acquisition with the new easy-to-see Green reticle that is approximately 6X easier to see than red in daytime. The EXPS2-GRN also maximizes rail space with its compact size and allows for co-witnessing of iron sights.

MODEL
518™

518.A65
518-2

BLACK

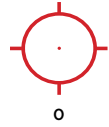

The best just got better. Get all of the features found in EOTECH's top sight, the EXPS, but with easy-to-find AA batteries. The 518 has buttons on the side that allow the user to position it close to the magnifier to reduce rail space.

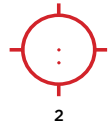

MODEL
300™ BLK

XPS2-300

BLACK

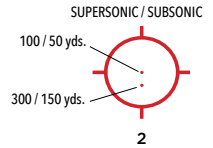

Designed with tactical shooters in mind, the XPS2-300 offers a two-dot ballistic drop reticle that allows the shooter to zero either Subsonic or Supersonic .300 Blackout rounds in the same reticle pattern.



MODEL
512™ XBOW

512.XBOW

BLACK

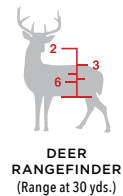

Designed with Crossbow hunters in mind, the Model 512 Crossbow sight utilizes the unique properties of holography to create optimal range scaling data in a heads-up display.

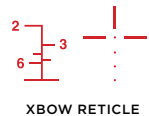

MAGNIFIERS



FEATURES

FOR G45™, G43™ AND G33™

Due to today's ever-changing scenarios, the need to transition quickly between Close-Quarters Combat (CQC) and medium-range target identification and engagement is vital. Maintaining a precise shot at both distances is a must. The ability to transition between the two distances almost instantly and still maintain weapon accuracy is easily achieved with our compact, fixed 3X or 5X magnifier.

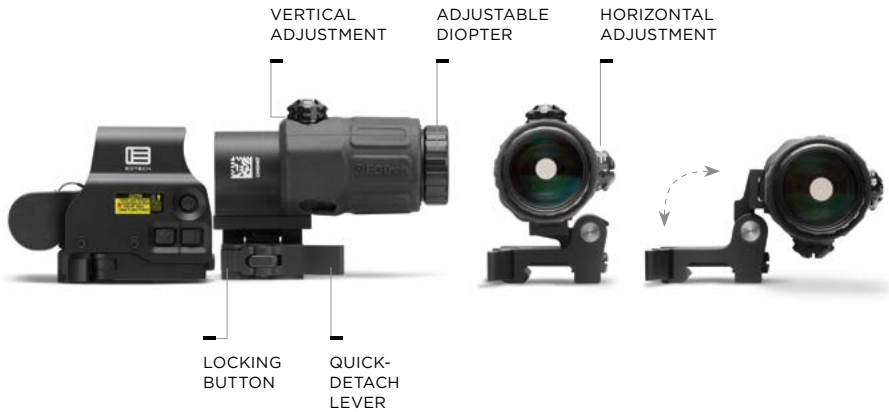

MAGNIFIERS

BASIC OPERATION FOR G33

The magnifier is designed to be used behind an EOTECH Holographic Weapon Sight (HWS®).

The magnifier can be mounted directly behind the HWS. Simply switch the magnifier out of the way for quick 1X targeting. When used with HWS Models 518, 558 and EXPS (with side button interface), the user can easily operate the sight even with the magnifier engaged.

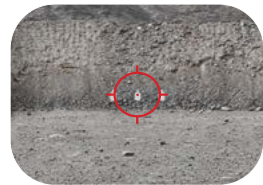

1X at 100 yards

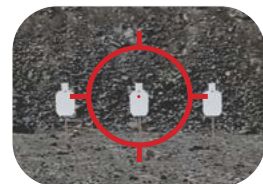

3X at 100 yards



THESE COMMODITIES ARE CONTROLLED UNDER THE EXPORT ADMINISTRATION REGULATIONS (EAR) AND MAY NOT BE EXPORTED WITHOUT PROPER AUTHORIZATION BY THE U.S. DEPARTMENT OF COMMERCE.

MODEL

G45™

NEW
2020

G45.STS

BLACK



The mini 5X Magnifier has the similar weight and dimensional properties as the existing G33 Magnifier, but with an additional 2X magnification for precision aiming at greater distances. The mount provides fast transitioning from 5X to 1X and the optic offers tool-free vertical and horizontal adjustments with a large field-of-view. The G45 works with all EOTECH HWS models.

MODEL

G43™

NEW
2020

G43.STS

BLACK



New for 2020, this is a miniaturized version of our battle-tested G33 Magnifier making it one of the most compact and lightweight magnifiers available. The mount provides fast transitioning from 3X to 1X and the optic offers tool-free vertical and horizontal adjustments with a large field-of-view. The G43 works with all EOTECH HWS models.

MAGNIFIERS



THESE COMMODITIES ARE CONTROLLED UNDER THE EXPORT ADMINISTRATION REGULATIONS (EAR) AND MAY NOT BE EXPORTED WITHOUT PROPER AUTHORIZATION BY THE U.S. DEPARTMENT OF COMMERCE.

MODEL

G33™

G33.STS
G33.STS Tan

BLACK

TAN



The G33 is the selected magnifier of USSOCOM, and is compact and lightweight. The mount provides fast transitioning from 3X to 1X, and the optic offers tool-free vertical and horizontal adjustments, larger field-of-view and an adjustable diopter for improved, precise focusing. The G33 works with all EOTECH HWS models.

MODEL

G30™

NEW
2020

G30.FM

BLACK



Providing shooters with the same great magnification properties as our battle-tested G33 Magnifier at less than half the cost, this new-for-2020 product features a quick-detach fixed mount for fast and simple mounting and unmounting behind an HWS. The G30 works with all EOTECH HWS models.

MAGNIFIERS

MODEL

HHS GREEN™

HHS GRN

 BLACK

EXPS2-0 GREEN RETICLE WITH A G33 MAGNIFIER

Regardless of the scenario, the Holographic Hybrid Sight Green (HHS GREEN), featuring an EXPS2-0GRN with a G33™ magnifier, provides an amazing advantage when transitioning from close-quarters to long-range shooting. Instant transition is achieved through a quick Switch-To-Side (STS) mount that offers a simple, quick disengagement of the magnifier. The Green reticle is approximately 6X easier to see than red in daytime, which can lead to faster target acquisition.

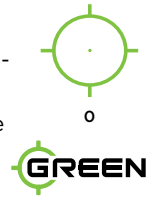

MODEL

HHS I™

HHS I

 BLACK

EXPS3-4 WITH A G33 MAGNIFIER

The Holographic Hybrid Sight I (HHS I), featuring an EXPS3-4 with a G33 magnifier, provides a solution for engaging threats in Close-Quarters Combat situations and then quickly to 600-meter targets. Instant transition is achieved through a Switch-To-Side (STS) mount that offers a simple and quick disengagement of the magnifier. This durable night vision-compatible system offers wide field optical performance for visibility in extreme low-light conditions.



MODEL

HHS II™

HHS II

BLACK



EXPS2-2 WITH A G33 MAGNIFIER

Regardless of the scenario, the Holographic Hybrid Sight II (HHS II), featuring an EXPS2-2 with a G33™ magnifier, provides an amazing advantage when transitioning from close-quarters to long-range shooting. Instant transition is achieved through a quick Switch-To-Side (STS) mount that offers a simple, quick disengagement of the magnifier.



2

MODEL

HHS III™

HHS III

BLACK



518-2 WITH A G33 MAGNIFIER

Complementing the Holographic Hybrid Sight (HHS) lineup, the HHS III, featuring a 518-2 with a G33 magnifier, delivers both close-quarters and long-range shooting capability. The HHS III takes EOTECH's top sight features and adds easy-to-find AA battery compatibility. A quick Switch-To-Side (STS) mount allows for fast, simple disengagement of the magnifier.



2

HWS[®] RETICLE

ADVANTAGES



EOTECH's Holographic technology provides a distinct advantage over typical red dots. EOTECH can offer any type of reticle pattern, as opposed to being limited to a single dot. EOTECH reticle designs are fabricated so that they can incorporate:

Multiple trajectory
points of aim

Range assist
features

Anti-torque or cant
visual indicators

VERSATILITY WITH OTHER WEAPON PLATFORMS

With its advanced holographic technology, the HWS® 2-dot reticle solves a number of fire control issues for a host of applications and weapon platforms.

LOAD	CENTER DOT FIRST ZERO	CENTER DOT SECOND ZERO	SECOND DOT ZERO	BOTTOM OF CIRCLE
.223 Cal. 62 Gr., 2,900 Vel.	50 yards	200 yards	500 yards	7 yards
.44 Mag. 240 Gr., 1,300 Vel.	25 yards	50 yards	165 yards	—
12 Gauge 385 Gr., 1,850 Vel.	25 yards	100 yards	250 yards	—
.50 Cal. Black Powder 350 Gr., 1,850 Vel.	25 yards	100 yards	250 yards	—

RANGE ESTIMATION WITH UNMAGNIFIED HWS

The standard ring found in most reticles equates to approximately 68" (5' 8") at 100 yards.

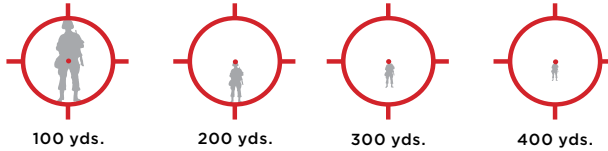

100 yds.

200 yds.

300 yds.

400 yds.

BRIGHTNESS

With multiple brightness settings, HWS technology offers quick adjustability to accommodate any shooting situation.



DARK



BRIGHT

HWS® RETICLE PATTERNS

EOTECH's reticle patterns greatly impact accuracy and fast target acquisition. Unlike traditional red dot technology, EOTECH's reticle patterns feature a 68 MOA ring surrounding a 1 MOA center dot, allowing the shooter to quickly pick up a target, HWS allows for more complex reticle designs with minimal parallax error.

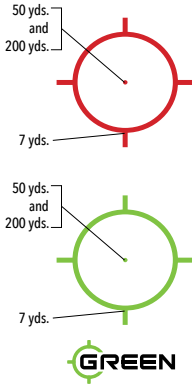

0 RETICLE

The most popular reticle offered, this 68 MOA ring with 1 MOA dot is ideal for fast target acquisition. It provides three usable aiming points. The aiming points above were based on the following load: .223 Cal. 62 Gr. 2,900 Vel. Other loads and calibers can also be used, but the operator will have to establish the ranges associated with the aiming points. When using a shotgun, the 68 MOA ring can be used to represent shot patterns, but will vary based on choke and shell selection. **For ordering this reticle, the model codes will end in -0.**

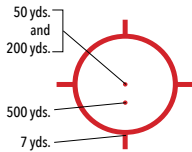

2 RETICLE

The two-dot reticle pattern can be easily distinguished with or without magnification. It provides two usable aiming points for both subsonic or supersonic rounds. Calculated using a 16" barrel and 110 Gr. supersonic and 220 Gr. subsonic ammunition. **For ordering this reticle, the model codes will end in -2.**

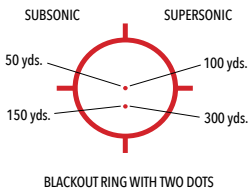

300 RETICLE

The two-dot reticle pattern in the 300 Blackout model provides two usable aiming points for both subsonic and supersonic rounds. Calculated using a 16" barrel and 110 Gr. supersonic and 220 Gr. subsonic ammunition. **For ordering this reticle, the model codes will end in -300.**

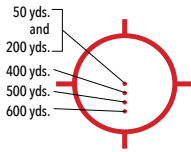

4 RETICLE

Use this ballistic reticle with 5.56 Nato/.223 Cal. with 62 Gr. M855 FMJ at roughly 2,680 fps with a 14.5" barrel. For ordering this reticle, the model codes will end in -4.

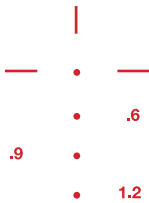

XR308 RETICLE

The XR308 reticle was designed specifically for the military M240 machine gun. It was calculated with a .308 Cal. with 150 Gr. M59 FMJ at roughly 2,800 fps with a 24.8" barrel.

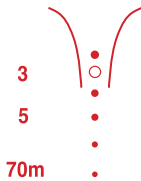

FN303 RETICLE

The FN303 pattern is designed to be used with FN Herstal's less lethal launcher (.68 Cal.).



SAGE RETICLE

The SAGE reticle pattern combines a targeting and ranging reticle in one image. It offers a range-assisted scale. The pattern was specifically developed for use with Sage Control Ordnance single and multiple projectile 37 mm rifled launchers. The multipurpose image is calibrated to the specific trajectory of Sage's KO line of less-lethal impact munitions.

vudu®

PRECISION OPTICS



FEATURES

The EOTECH line of Vudu® rifle scopes — where durability, precision and versatility meet. Vudu is engineered and constructed to meet the most rugged demands of the serious precision shooter. Starting from a solid piece of aircraft-grade aluminum and finished with the highest-quality AR-coated, high-density (HD) glass and surgically precise turret systems, the Vudu line of rifle scopes lets you deliver that critical shot when it matters most.

Many models feature a first focal plane optic design allowing for quick and accurate target ranging at all magnification levels, and the exceptionally bright illuminated reticle will let you take that shot during the difficult low-light hours of dawn and dusk. Whether you need a premium optic for hunting or competition, or to meet demands in the line of duty, Vudu scopes will get the job done — period. All this at a more affordable price compared to other high-quality first focal plane scopes.



ONE-PIECE EYEPIECE

Magnification ring allows easy, fluid transition from low to high



TACTICAL TURRETS

Ability to re-index to “0” (Zero Stop)



THROW-LEVER

Included for quick magnification changes



PUSH-BUTTON ILLUMINATION

Illuminated reticle with 10 brightness settings and 2-hour shutoff



OBJECTIVE LENS

Extremely clear XC High-Density glass with excellent light transmission

VUDU® PERFORMANCE CHARACTERISTICS

APPLIES TO MOST MODELS



VUDU® PRECISION OPTICS

OPTICAL

XC™ High-Density glass for exceptional edge-to-edge clarity and resolution

Etched, illuminated reticle ensures outstanding accuracy even in low-light conditions

Fully multi-coated lens for unparalleled light transmission and color reproduction

CONSTRUCTION

Aircraft-grade aluminum single-piece construction

Hard anodized, durable finish

Water-, internal fog-, and shock-resistant

Push-button illumination controls, 10 brightness settings and 2-hour auto off

One-piece eyepiece for easy, fluid transitions, threaded throw lever included

TURRETS

Surgically precise EZ-Clik™ turrets

EZ Chek Tactical turrets for quick return to zero (on some models)

Short throw-locking elevation turret (5-25X50)



PROOF
Research

EC



MODEL **vudu®**
1-8X24SFP **NEW**
2020

VDU1-8SFHC3

BLACK



Like other Vudu scopes, the 1-8X24 SFP features aircraft-grade aluminum construction and bright XC High-Density glass, surgically precise turrets, and intuitive push-button reticle illumination controls. The HC3 quad-level BDC reticle features a precise 0.5-MOA illuminated center dot and 2-, 5-, 8.5- and 12.5-MOA subtensions on the vertical axis (at 8X power). The scope's field of view at 100 yards is 105.8 feet at 1X and 13.2 feet at 8X.



MODEL

vudu® 1-6X24FFP

VDU1-6FFSR1
VDU1-6FFSR2
VDU1-6FFSR3

BLACK



OPTIC OF THE YEAR



On/Off and
Illumination
Buttons

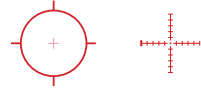

FOV@1X FOV@6X

SR-1 (MRAD)

This is an optic that feels at home on the AR platform or on a bolt action rifle. The EOTECH Speed Ring reticle allows for fast target engagement at low power, but at higher power provides the resolution and accuracy required to tackle longer shots. The Vudu 1-6X is the perfect solution for short- to medium-range applications.



FOV@1X FOV@6X

SR-2 (7.62 mm BDC),
SR-3 (5.56 mm BDC), (MOA)

MODEL

vudu® 2.5-10X44FFP

VDU2-10FFH59
VDU2-10FFMD1
VDU2-10FFMD2

BLACK



Tactical Turrets

The 2.5-10X Vudu rifle scopes provide the perfect combination of speed and accuracy to tackle those tough shots. The extremely clear XC High-Density glass and first focal plane optical design allow you to range and shoot with the utmost speed and precision. When precision, accuracy, durability and image clarity matter most for your mid-range engagements, choose Vudu 2.5-10X.

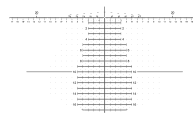

HORUS H59

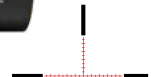

MD1-MRAD

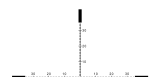

MD2-MOA

VUUDU® PRECISION OPTICS

MODEL
vudu®
3.5-18X50FFP

VDU3-18FFH59
 VDU3-18FFMD1
 VDU3-18FFMD2

BLACK



Parallax
Adjustment

The Vudu 3.5-18X50 provides a robust 34 mm tube, XC High-Density glass, and is loaded with other performance features required to take that precise long-range shot. The oversized and precision-machined turrets, with EZ Chek Zero Stop feature, let you quickly dial adjustments and return to zero, even in low-light conditions. The side-mounted parallax adjustment allows you to easily dial-in the reticle focus.

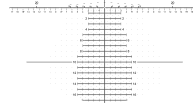

HORUS H59

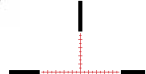

MD1-MRAD

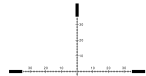

MD2-MOA

MODEL
vudu®
5-25X50FFP

VDU5-25FFH59
 VDU5-25FFMD3

BLACK



Parallax
Adjustment

The Vudu 5-25X50 is ideal for short platform rifles. At approximately 11.2 inches in length, the 5-25X is one of the shortest first focal plane rifle scopes on the market. The elevation turret includes a push/pull locking system and EOTECH's EZ Chek Zero Stop. One unique advantage of the short design is that it provides the ability to attach either a clip-on night vision or thermal device in front of the scope.

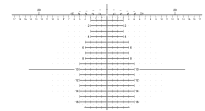

HORUS H59

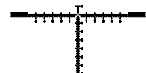

MD3

MODEL
vudu®
3.5-18X50SFP

VUDU3-18SFHC1

BLACK



Parallax
Adjustment

The Vudu 3.5-18X50 Second Focal Plane scope is the ideal scope for medium- and long-range shooting. It features EOTECH's XC™ High-Density glass, rugged 34 mm tube and easy-to-use tactical turrets equipped with covers.

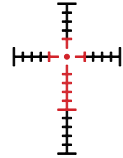

HC1

MODEL
vudu®
8-32X50SFP

VUDU8-32SFHC2

BLACK

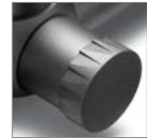

Capped,
Competition
Turrets

EOTECH's 8-32X50 is ideal for competitive and recreational long-range shooting. It features competitive turrets with large, easy-to-read minute-of-angle adjustments. The turrets are calibrated in .125 MOA (1/8" per click), offering extreme precision and accuracy.

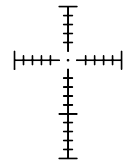

HC2

MOUNT
CANTILEVER

MN2015 MN2016
PRS 2" | 30 mm PRS 2" | 34 mm

Complement your new rifle scope is with EOTECH's high-quality cantilever mount. The Cantilever mount includes an adjustable, locking quick-detach lever for easy removal and attachment.



VUDU® RETICLE PATTERNS



SR-1

The SR1 incorporates the iconic EOTECH illuminated speed ring along with a hashmarked inner crosshair reticle that uses MRAD sub-tension lines for ranging, holdover and wind compensation. The first focal plane design allows for lightning fast target acquisition using the speed ring at the lower power settings. When the magnification setting is dialed up, the speed ring disappears from view and the inner crosshair comes in to view for more precision on longer range shots.

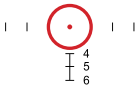

SR-2

The SR2 incorporates the iconic EOTECH illuminated speed ring along with a BDC inner reticle calibrated for the 7.62 mm (M118LR) out to 600 yards. The first focal plane design allows for lightning fast target acquisition using the speed ring at the lower power settings. When the magnification setting is dialed up, the speed ring disappears from view and the inner BDC comes into view for more precision on longer-range shots.

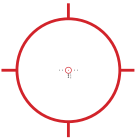

SR-3

The SR3 incorporates the iconic EOTECH illuminated speed ring along with a BDC inner reticle calibrated for the 5.56 mm (75gr. BTHP) out to 600 yards. The first focal plane design allows for lightning fast target acquisition using the speed ring at the lower power settings. When the magnification setting is dialed up, the speed ring disappears from view and the inner BDC comes into view for more precision on longer-range shots.



MD1

The MD1 is a first focal plane MRAD-based hashmark reticle that provides ranging, holdover and wind compensation in a very clean sight picture. The entire crosshair is illuminated for excellent low-light visibility. MD1 is an excellent all-purpose reticle for the shooter who prefers MRAD-based sub-tensions.

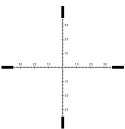

MD2

The MD2 is a first focal plane MOA-based hashmark reticle that provides ranging, holdover and wind compensation in a very clean sight picture. The entire crosshair is illuminated for excellent low-light visibility. MD2 is an excellent all-purpose reticle for the shooter who prefers MOA-based sub-tensions.

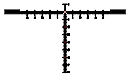

MD3

The MD3 is a first focal plane MRAD-based hashmark reticle that provides ranging, holdover and wind compensation in a very clean sight picture. The stadia lines are pulled back from the illuminated center aiming dot for improved long-range accuracy.

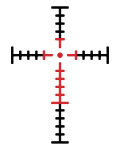

HC1

The HC1 is a second focal plane MOA-based hashmark reticle that provides holdover and wind compensation in a very clean sight picture. The illuminated center crosshairs provide excellent low-light visibility and are pulled back from the aiming dot for greater accuracy. The HC1 is an excellent choice for most hunting conditions.

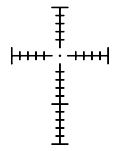

HC2

The HC2 is a second focal plane MOA-based hashmark reticle that was designed for the precision long-range shooter. The non-illuminated crosshairs allow for elevation and windage correction, while the ultra-small center aiming dot (0.15 MOA at 32X) provides the utmost accuracy. The HC2 is an excellent choice for precision long-range shooting such as Benchrest, F-Class and prairie dog hunting.



HC3

The HC3 is a second focal plane MOA-based hashmark reticle that was designed specifically for the 3-gun competition shooter. The quadplex BDC reticle features a precise 0.5 MOA daylight-visible illuminated center dot and four sub-tension hash marks providing precise ballistic holdovers for those longer shots. The HC3 reticle is also an excellent choice for shooters interested in a short to mid-range low power variable hunting optic.

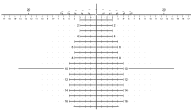

H59

The MRAD-based H59 reticle features the popular horizontal and vertical grid pattern that allows for built-in range-finding, holdovers and wind compensation to maximize extreme-range precision. The windage tree is also perfect for quick follow-up corrections.

NOTES

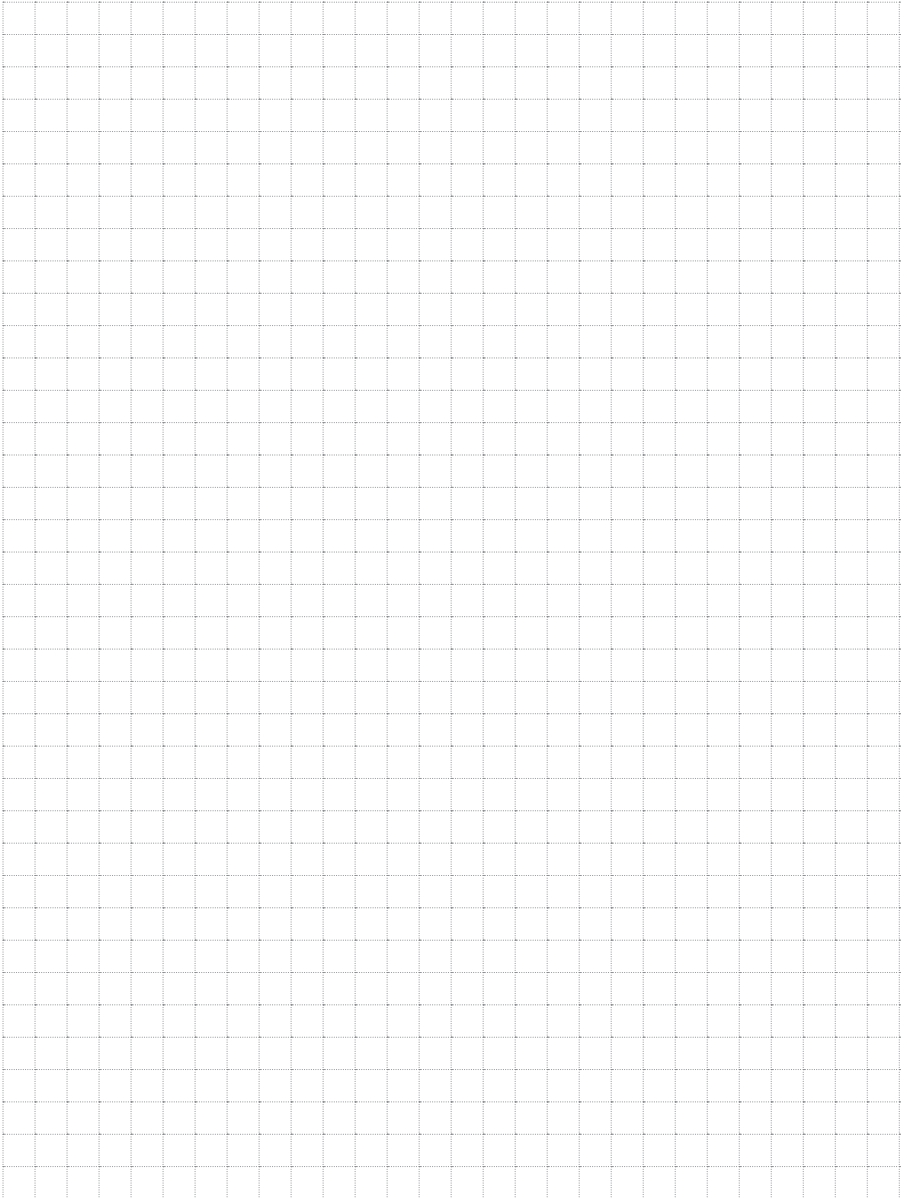

NOTES

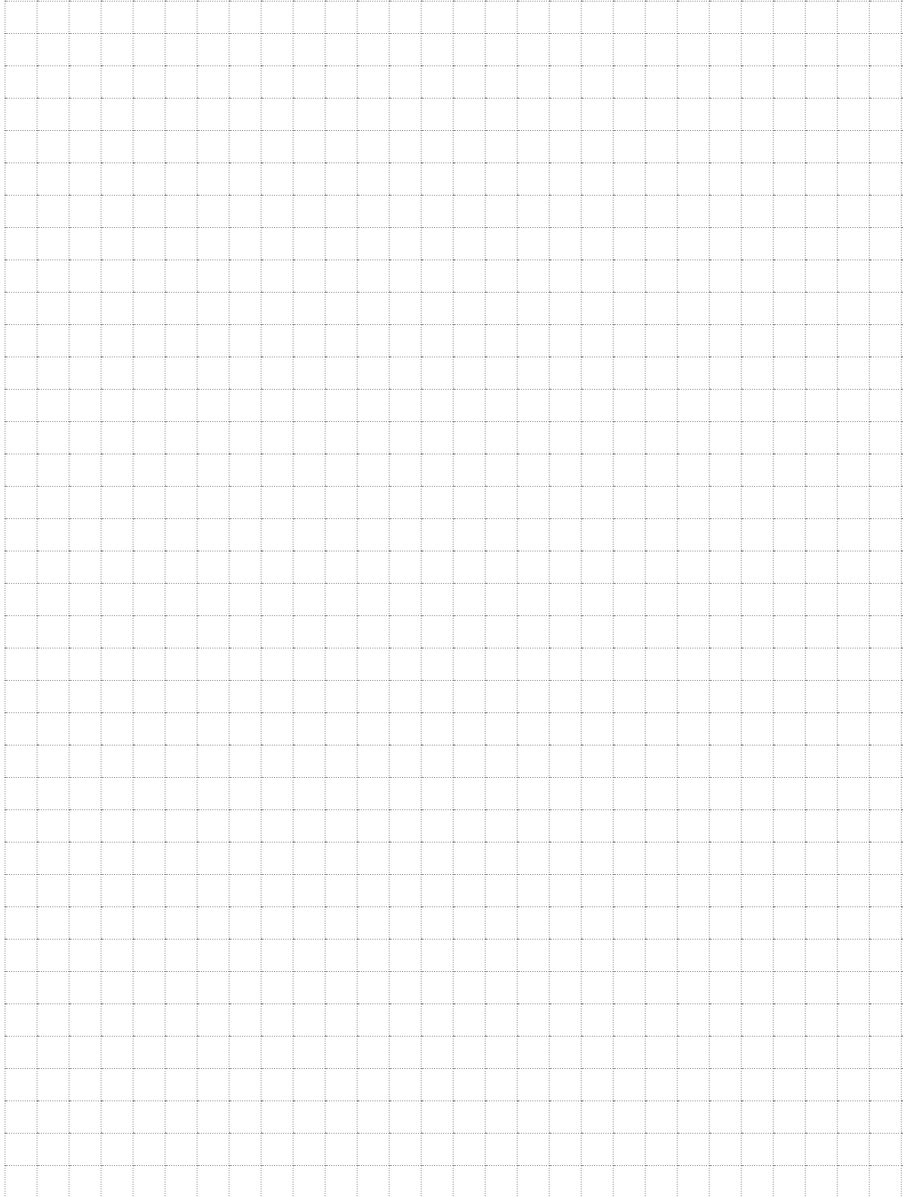

NOTES

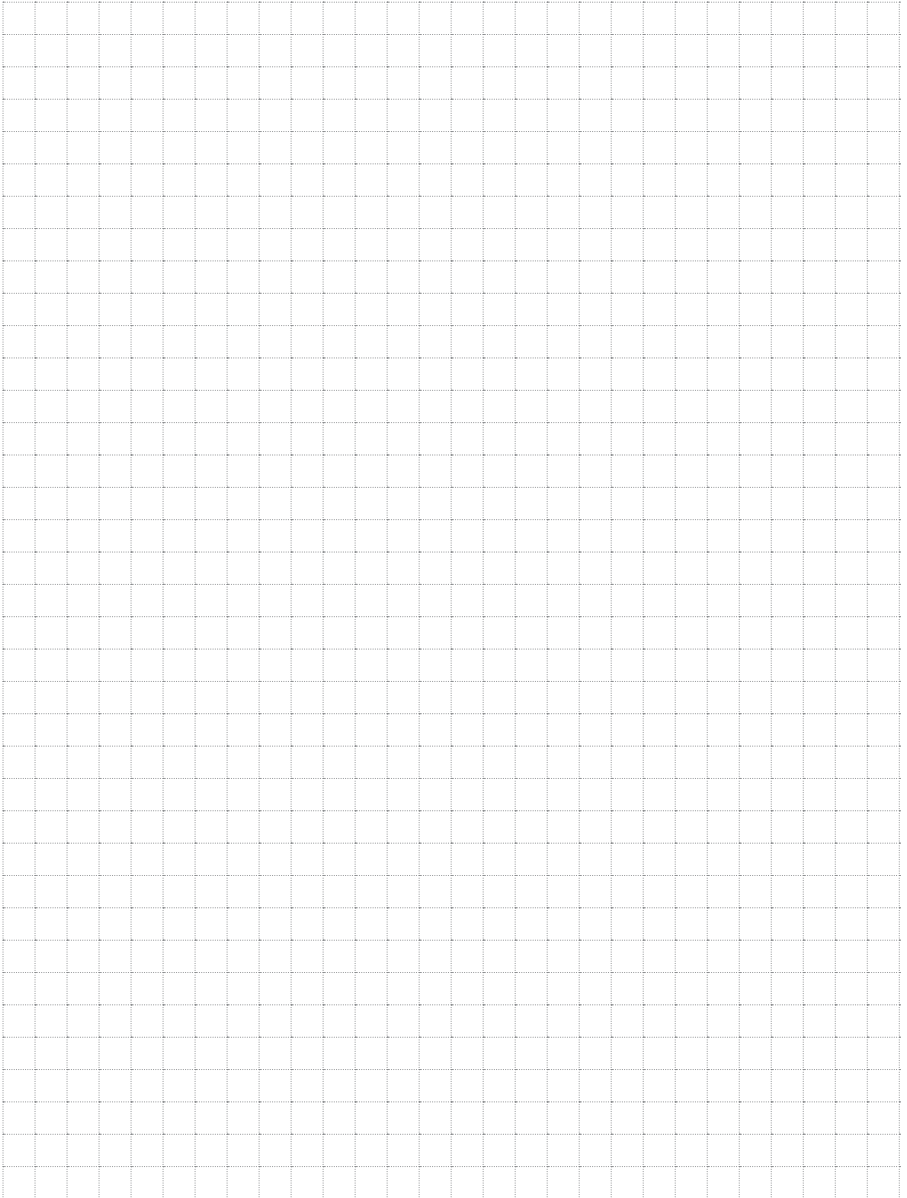

DISCLAIMERS

ALL EOTECH MATERIALS ARE FOR INFORMATIONAL PURPOSES ONLY AND DO NOT CONSTITUTE ANY BINDING OBLIGATIONS OR AGREEMENT BY EOTECH OR L3HARRIS TECHNOLOGIES, INC.

ALL CLAIMS ABOUT PERFORMANCE AND PERFORMANCE CHARACTERISTICS ASSUME NORMAL, RESPONSIBLE USAGE WITHIN THE WARRANTY PERIOD.

EOTECH RESERVES THE RIGHT TO CHANGE THE PRODUCT SPECIFICATIONS AT ANY TIME WITHOUT NOTICE. ALL OPTICAL DEVICES ARE SUSCEPTIBLE TO TEMPERATURE VARIATIONS. EOTECH USERS THEREFORE MAY EXPERIENCE A POINT OF IMPACT SHIFT AWAY FROM THE POINT OF AIM WHEN THE SIGHT IS USED AT A TEMPERATURE SIGNIFICANTLY DIFFERENT FROM THE TEMPERATURE AT WHICH THE SIGHT WAS ZEROED. THE TYPICAL SHIFT IS BETWEEN APPROXIMATELY 1.4 MOA AND 1.8 MOA FOR CURRENT SIGHTS.

ALL EOTECH SIGHTS EXHIBIT A VARYING DEGREE OF PARALLAX DEPENDING ON OPERATING CONDITIONS.

PATENTS – ONE OR MORE OF THESE PRODUCTS MAY BE COVERED BY ONE OR MORE OF THE FOLLOWING U.S. PATENTS: 5,374,986; 5,400,540; 5,430,967; 6,185,854; 6,190,025; 6,574,901; 7,493,722; D522,031; D568,508 AND D595,439.

THIS DOCUMENT CONSISTS OF GENERAL CAPABILITIES INFORMATION THAT IS NOT DEFINED AS CONTROLLED TECHNICAL DATA UNDER ITAR, PART 120.10 OR EAR, PART 772.



1201 EAST ELLSWORTH RD.
ANN ARBOR, MI 48108 USA
+1 888-368-4656

VISIT US AT
EOTECHINC.COM



© 2020 L3Harris Technologies, Inc.

EOTECH®, VUDU®, HWS® and Holo Sight® are
registered trademarks of L3Harris Technologies Inc.
in the United States and other countries.

All product names, trademarks and registered trademarks are property of their respective owners.
Use of these names, trademarks and brands does not imply endorsement.